

Operating Instructions

Series SD10000 Spring Driven Reels

SD13035 OLP	SD13000 OMP	FSD13050 OLP
SD13050 OLP	SD13035 OVP	FSD13000 OLP
SD13000 OLP	SD13050 OVP	FSD14035 OLP
SD14035 OLP	SD13000 OVP	FSD14050 OLP
SD14050 OLP	SD14035 OVP	FSD14000 OLP
SD14000 OLP	SD14050 OVP	FSD14005 OLP
SD14005 OLP	SD14000 OVP	SD14050 OLP-HTH
SD13035 OMP	SD14005 OVP	
SD13050 OMP	FSD13035 OLP	



SD13050 OLP

Dimensional Data

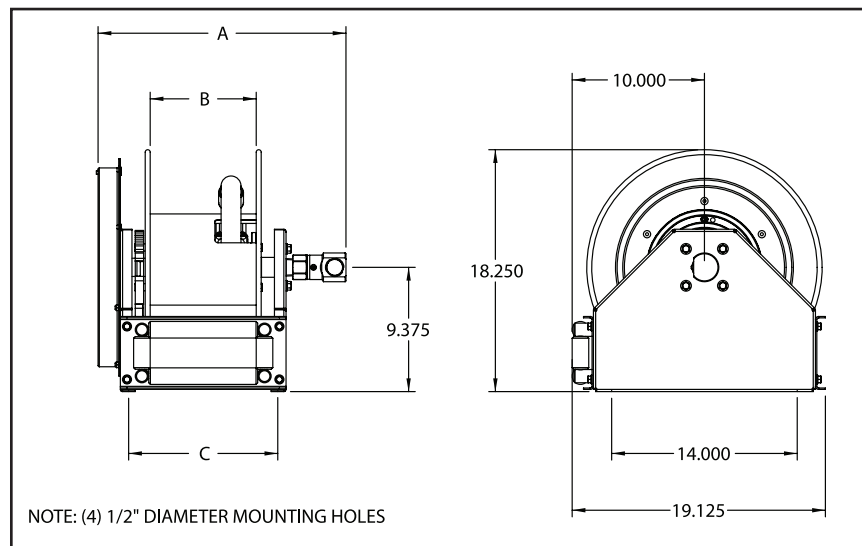

Model w/ hose	Model w/o hose	A	B	C	Model w/ hose	Model w/o hose	A	B	C
SD13035 OLP	SD13000 OLP	18 3/4	8	11 1/4	SD13035 OMP	SD13000 OMP	18 3/4	8	11 1/4
SD13050 OLP	SD13000 OLP	18 3/4	8	11 1/4	SD13050 OMP	SD13000 OMP	18 3/4	8	11 1/4
SD14035 OLP	SD14000 OLP	18 3/4	8	11 1/4	SD13035 OVP	SD13000 OVP	18 3/4	8	11 1/4
SD14050 OLP	SD14005 OLP	20 3/4	10	13 1/4	SD13050 OVP	SD13000 OVP	18 3/4	8	11 1/4
FSD13035 OLP	FSD13000 OLP	18 3/4	8	11 1/4	SD14035 OVP	SD14000 OVP	18 3/4	8	11 1/4
FSD13050 OLP	FSD13000 OLP	18 3/4	8	11 1/4	SD14050 OVP	SD14005 OVP	20 3/4	10	13 1/4
FSD14035 OLP	FSD14000 OLP	18 3/4	8	11 1/4	SD14050 OLP-HTH	-----	20 3/4	10	13 1/4
FSD14050 OLP	FSD14005 OLP	20 3/4	10	13 1/4					

*All dimensions are in inches.

Form# 1222-611 Rev: 8/2021

Safety

Read all instruction manuals, tags, and labels before operating this equipment. Personal injury and/or equipment damage may result if proper safety precautions are not observed.

- This hose reel is for professional use only. Use the hose reel only for its intended purposes. If you are unsure call your Reelcraft distributor.
- Check the hose reel and related equipment daily. Repair or replace worn or damaged parts immediately.
- Do not alter or modify this hose reel in any way. Use only genuine Reelcraft parts and accessories.
- Ensure that the hose reel is securely mounted before connecting the input and output hoses.
- Ensure that the reel, hose, and equipment being serviced are properly grounded. Use an ohmmeter to check ground continuity.
- Before connecting the hose reel to the supply line, ensure that the pressure does not exceed the maximum pressure of the lowest rated component within the system.
- Only use fluids, gases or solvents that are compatible with the exposed parts of the hose reel.
- If a leak occurs in the hose or reel, relieve the system pressure immediately. Bleed the fluid or gas pressure before servicing the hose reel.
- A high tension drive spring is contained within the hose reel. Exercise extreme caution.
- If the hose reel ceases to unwind or rewind, relieve the system pressure immediately. Do not pull or jerk on the hose.
- Be aware of machinery and personnel in the work area. Route hoses away from traffic areas, sharp edges, moving parts, and hot surfaces.
- Pull the hose from the reel by grasping the hose itself, not the control valve.
- Treat and respect the hose reel as you would any other piece of machinery, observing all common safety practices.
- Never allow hose to retract unassisted, always walk the hose back to the reel until the bumper engaged the guide roller. Failure to do so can result in damage to the hose, hose reel and any surrounding equipment or personnel.

Warnings

Hazardous fluid or toxic fumes can cause serious injury or death if inhaled, swallowed, splashed in the eyes, or splashed on the skin.

- Know the specific hazards of the fluid you are using.
- Store hazardous fluid in an approved container. Dispose of hazardous fluid according to all local, state and national guidelines.
- Always wear protective eyewear, gloves, clothing, and a respirator as recommended by the fluid and solvent manufacturer.

Improper grounding, poor ventilation, open flames, or sparks can cause a hazardous condition and result in a fire or explosion and serious injury.

- For fueling applications, be sure the entire fluid system is properly grounded. The hoses installed with these hose reels must be electrically conductive. The hose reel is grounded by connecting electrically conductive supply hoses to a properly grounded system.
- If there is any static sparking or you feel an electric shock while using this equipment, stop dispensing immediately. Do not use the equipment until you identify and correct the problem.
- Provide fresh air ventilation to avoid the buildup of flammable fumes from solvents or the fluid being dispensed.
- Keep the dispensing area free of debris, including solvent, rags, and spilled gasoline.
- Do not smoke while dispensing flammable fluids.

Installation Instructions

Unless the hose reel was specified differently when ordering, the maximum installation height is 16 feet. Do not exceed this distance. This reel is of a compact design and is intended for mounting where the operator can guide the hose onto the reel to avoid piling in any one area on the spool. **Ceiling mounting is not recommended.**

1. Unpack and inspect the hose reel for damage. Turn by hand to check for smooth operation. Check for completeness.
2. Secure the hose reel into place using 4 customer supplied bolts. Hose reel has 4 – 1/2” diameter holes for mounting. Secure the hose reel with a 3/8” – 1/2” bolts with washers.

Installing the Input Hose

Ensure that the supply line pressure does not exceed the maximum working pressure of the hose reel. Apply pipe thread sealant to all threads. Use a flexible hose connection at the input connection. Do not use rigid plumbing.

1. Connect supply line hose (inlet hose) to the swivel as indicated in Fig. 1.

Installing the Output Hose

⚠ Warning: Use extreme caution; reel under tension. Avoid releasing latch mechanism. Apply pipe thread sealant to all threads.

1. Relieve the pressure and bleed the line of all fluid. It is recommended that the supply line be removed from the supply source to eliminate the possibility of pressurized fluid injuries and/or accidental spills.
2. Ensure that the hose reel has been mounted securely, following the steps listed above under Installation Instructions.
3. Place a piece of tape on the side of the reel flange as a visual reference point for counting spool rotations.
4. Unlatch the hose reel spool, and allow it to slowly rotate until all the spring tension has been released. Then rotate the spool in the direction of the arrow shown in Fig. 1 to achieve the proper amount of spring tension for the hose you are installing. **Important:** Release the reel only at points where it is securely latched. See the chart below for the proper number of turns for your length of hose.

Hose I.D. (Inches)	Hose Length (Feet)	Number of Turns	Hose I.D. (Inches)	Hose Length (Feet)	Number of Turns
3/4”	35’	13	1”	35’	12
3/4”	50’	17	1”	50’	16

5. As a safety precaution, attach a C-clamp to the reel flange, as shown in Fig. 1, to help prevent the spool from unintentionally becoming unlatched and spinning freely.
6. Uncoil and extend the new hose, and loosely install the bumper stop near the outlet end of the hose.
7. Attach the other end of the new hose to the gooseneck, securing it with pipe sealant compatible with the fluids being used in the hose reel.
8. Remove the C-clamp from the reel flange.
9. Pull the hose firmly enough to release the latch, and then slowly allow the hose to retract.
10. Ensure that the hose can be pulled out all the way and that it fully retracts. If it does not pull out or retract properly, see Adjusting Spring Tension on the next page.
11. Position the bumper stop so that the hose extends far enough for all operators to reach the dispensing valve.
12. Pressurize the reel assembly and check all connections for leaks. Repair any connections showing signs of leakage.

Fig. 1

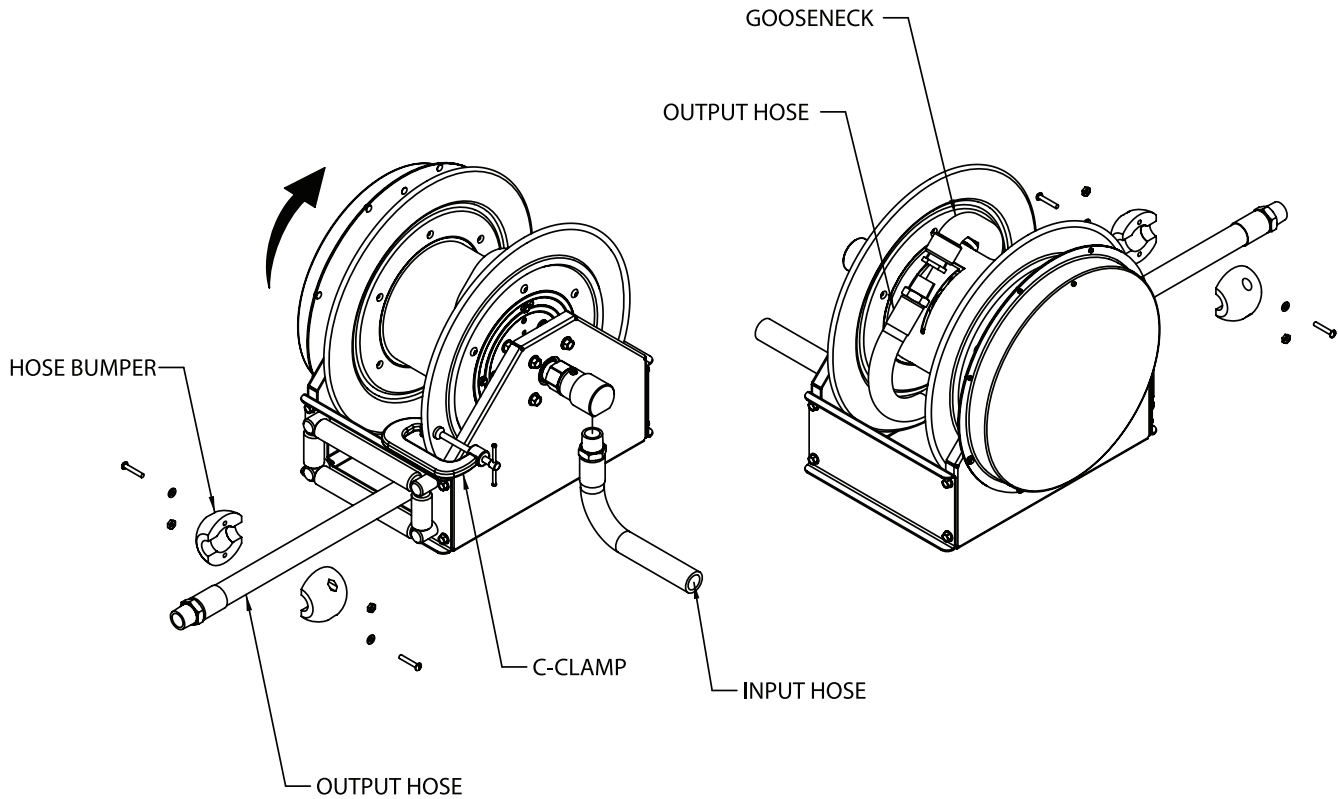

Adjusting Spring Tension

If the hose cannot be pulled all the way out, or if it does not retract all the way back onto the hose reel, you may need to adjust the spring tension. To do so follow these steps:

1. Relieve the pressure and bleed the line of all fluid. It is recommended that the supply line be removed from the supply source to eliminate the possibility of pressurized fluid injuries and/or accidental spills.
2. Pull the hose out and engage the latch.
3. Remove the dispensing valve (not shown) and bumper stop.
4. Pull the loose end of the hose back in through the hose rollers, and manually wrap the hose onto the reel.
5. Rotate the reel in the direction of the appropriate arrow shown in Fig. 2, keeping the hose wrapped on the reel.
6. Check the spring tension after each rotation. The hose must pull out and retract fully.
7. Repeat steps 4 and 5 until you have the proper amount of spring tension.

⚠ Caution: Do not increase the spring tension to the point that the spring winds up tightly before the hose is fully extended. A spring that is wound up too tightly stops the reel from rotating before the hose is fully extended, which puts excessive strain on the hose and reel drive spring and could damage the reel.

8. Reroute the hose through the hose rollers, and reinstall the bumper stop and dispensing valve

Fig. 2

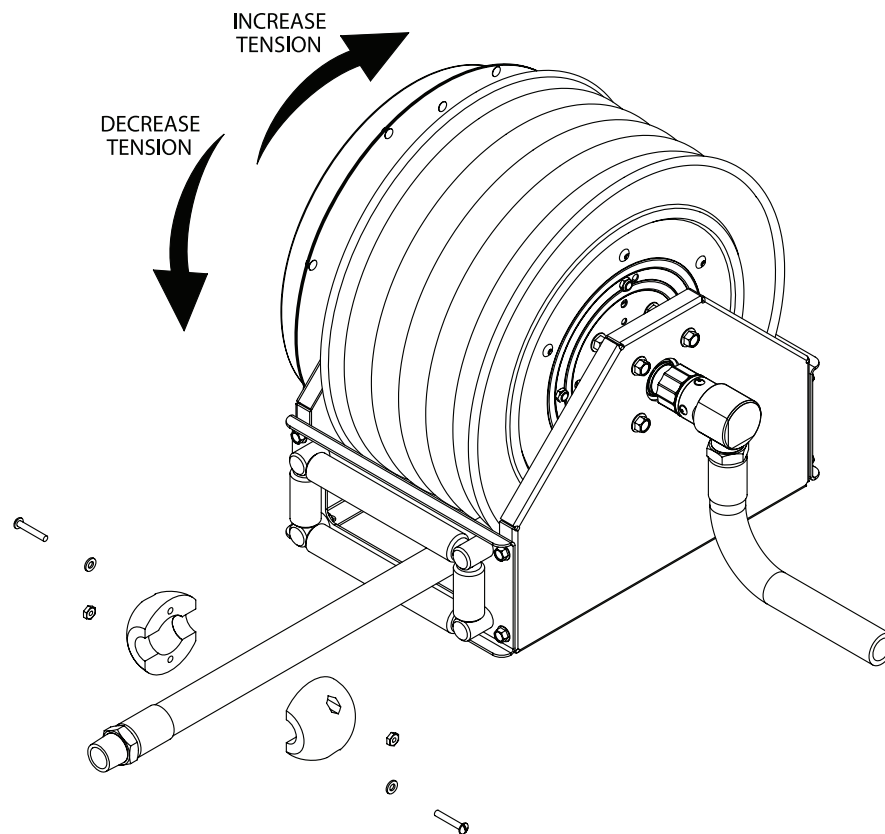

Service Instructions

Spring Canister

To replace the spring canister, follow the steps below. **Do not attempt to service the spring inside the spring canister.**
⚠ Warning: The only service you should perform on the reel spring is replacing the spring canister. The spring is under extreme tension and could be propelled out of the opened canister and cause serious injury.

1. Relieve the pressure and bleed the line of all fluid. It is recommended that the supply line be removed from the supply source to eliminate the possibility of pressurized fluid injuries and/or accidental spills.
2. Remove dispensing valve and bumper stop.
3. Unlatch reel and let the reel unwind fully to a free state before beginning disassembly. Do not allow the reel to unwind unassisted. You risk damage to the hose threads, reel and personnel.
4. Remove the four 1/4"-20 nyloc nuts holding the spring and case assembly to the side frame.
5. Pull the spring and case assembly free from the side frame as shown in Fig.3.
6. Locate the new spring case and take note of the location of the "hook" on the end of the spring as shown in Fig.4.
7. Attach new spring and case assembly to side of the reel aligning the female hook of the drive spring to the male hook on the arbor.
8. Replace four 1/4"-20 nyloc nuts and tighten securely.
9. Follow adjusting spring tension instructions above to properly tension the spring for your application after replacing the spring.

Fig. 3

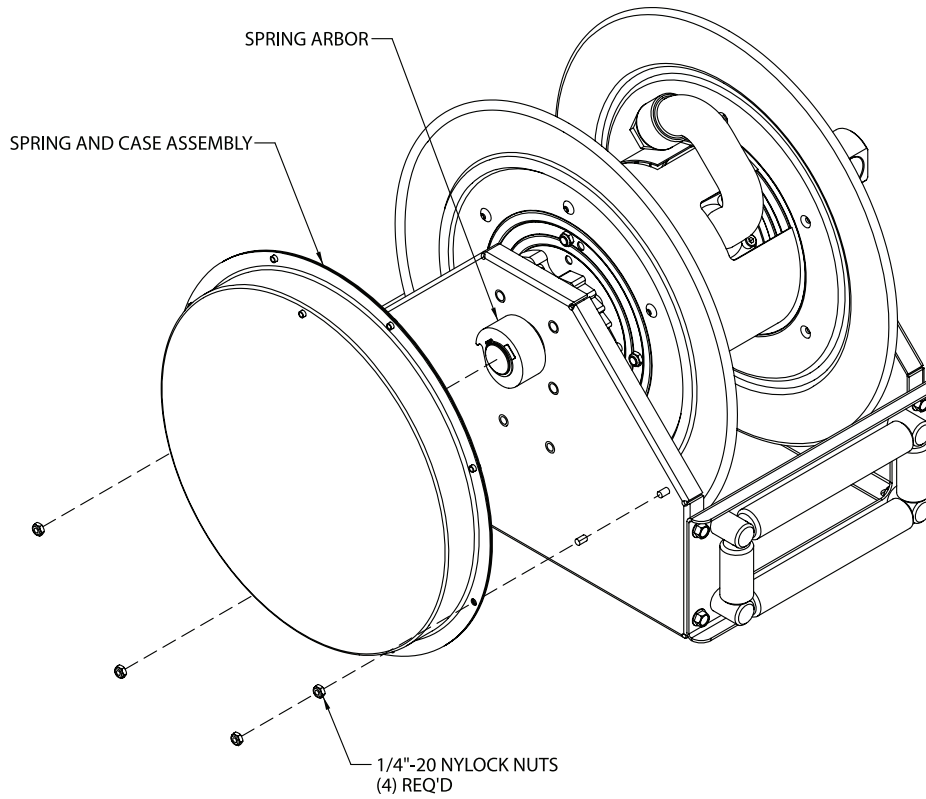
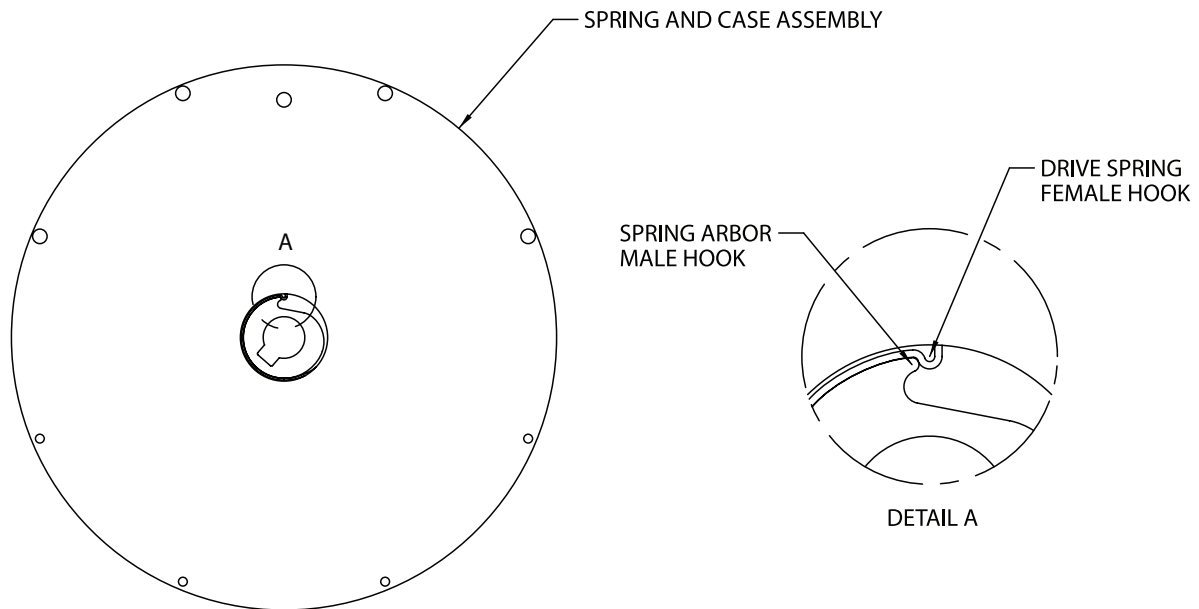

Fig. 4



Fluid Path Static Seal

Your hose reel is suited to be used with Air, Water, Oil, and Various Fuels. If a substance incompatible with the seal inside the fluid path is pumped through the reel, the o-ring seal between the gooseneck and spindle may degrade and cause the fluid path to leak. Verify with Reelcraft Engineering Department for hose reel compatibility with questionable substances. If a leak should occur, contact Reelcraft to establish proper o-ring replacement and follow the steps below for o-ring replacement.

1. Relieve the pressure and bleed the line of all fluid. It is recommended that the supply line be removed from the supply source to eliminate the possibility of pressurized fluid injuries and/or accidental spills.
2. Pull the hose assembly completely from the spool and latch the reel.
3. Attach a C-clamp to the reel flange to help prevent the reel from unintentionally becoming unlatched and spinning freely.
4. Remove the outlet hose from the gooseneck (optional).
5. Remove the four bolts attaching the gooseneck to the spindle.
6. Remove the gooseneck and o-ring from the fluid path spindle. Check the o-ring groove for debris and remove any residual fluid that may be present. All surfaces of the gooseneck and spindle should be clean and free of debris.
7. Replace appropriate o-ring by placing it in the groove of the spindle.
8. Replace the gooseneck and secure it in place with four socket head cap screw.

Fig. 5

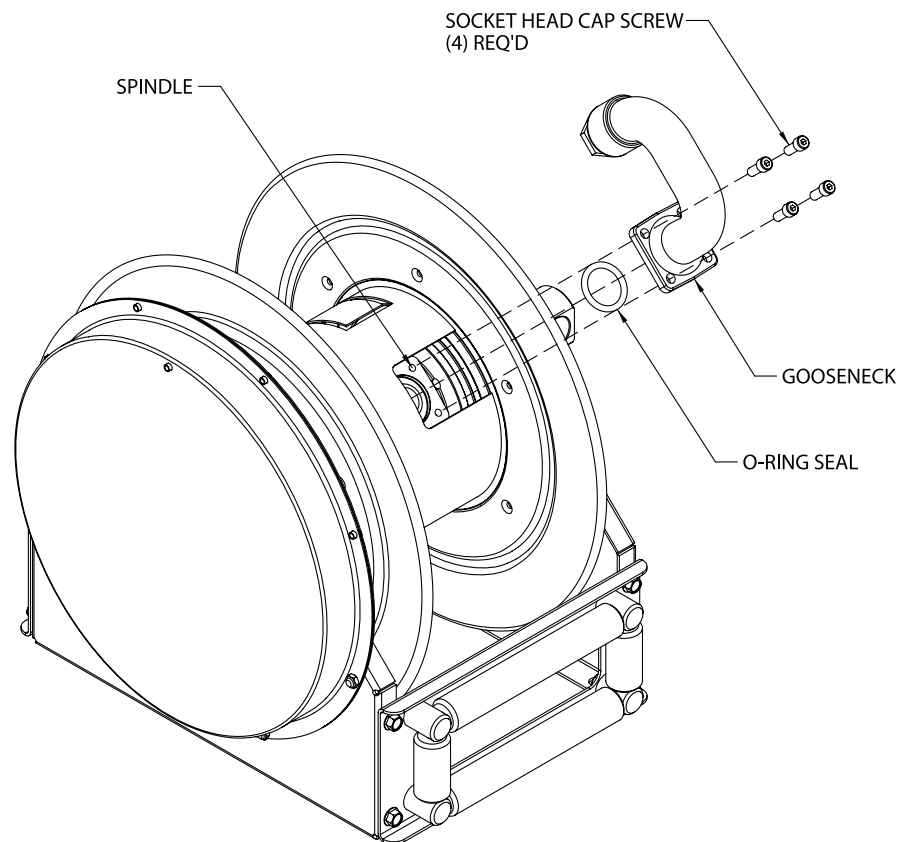

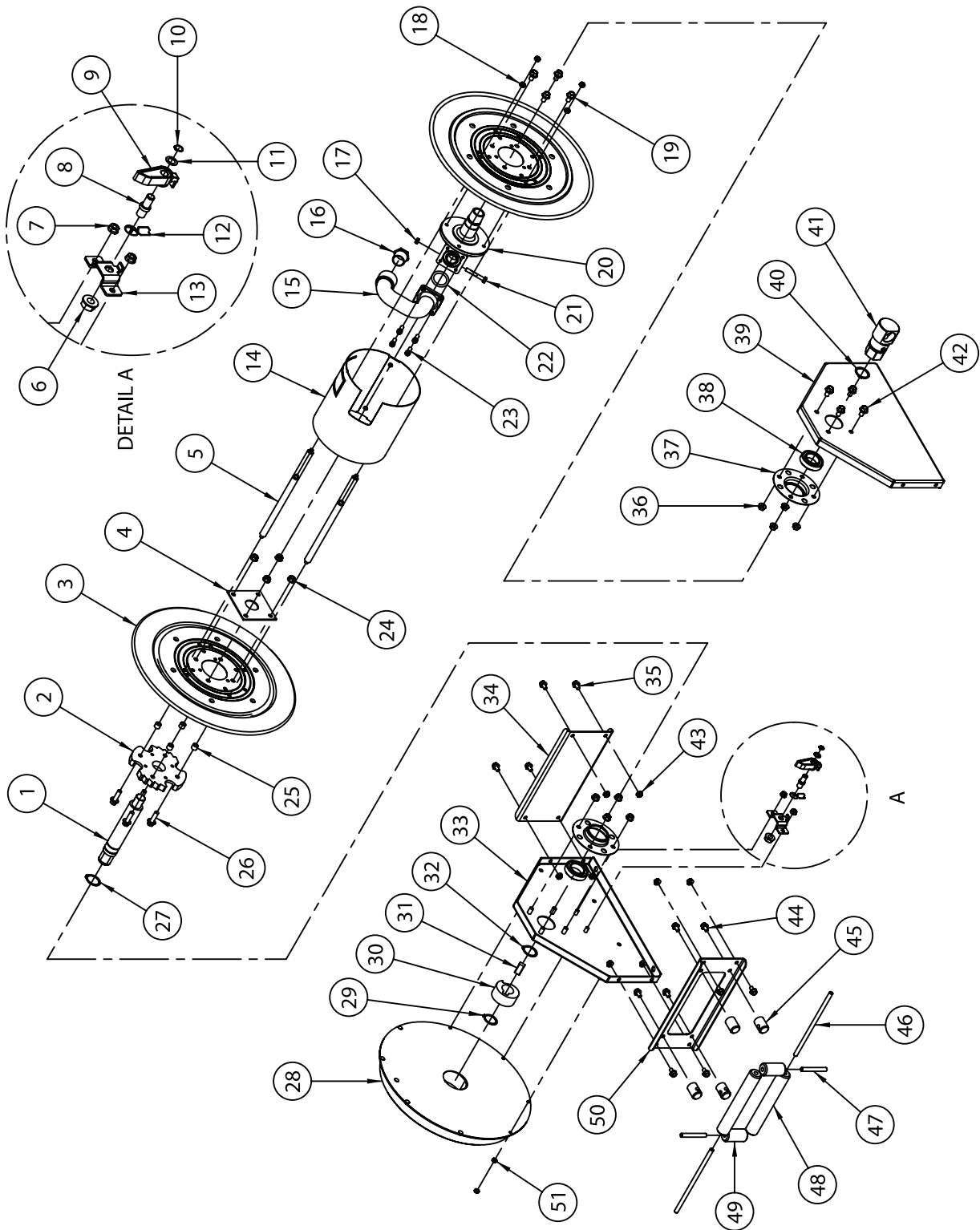

Parts Common to all Models

Item No.	Part No.	No. Req'd	Description	Item No.	Part No.	No. Req'd	Description
2	262526	1	Latch ratchet	26	S44-6	4	Machine screw
3	S260399-3	2	Spool flange	27	S140-34	1	Snap ring
4	262525-35	1	Head insert	29	300007	1	Snap ring
6	S280-8	1	Hex flange nut	30	261274	1	Spring arbor
7	300107	2	Lock nut	31	261275	1	Spring arbor key
8	262530	1	Latch pawl stud	32	S140-34	1	Snap ring
9	262118	1	Latch pawl	33	602453	1	Side frame & stud assembly
10	S140-6	1	Snap ring	35	S44-10	8	Machine screw
11	1-114901-2	1	Wear washer	36	S281-6	8	Hex flange nut
12	261616	1	Torsion spring	37	261304	2	Bearing flange
13	262529	1	Latch pawl bracket	38	261305	2	Sealed ball bearing
15	262455-1NPT	1	Fluid path gooseneck	39	262527	1	Side frame (inlet side)
17	S85-7	1	Nylock nut	40	S140-34	1	Snap ring
18	S85-7	8	Nylock nut	42	S44-2	4	Machine screw
19	S44-2	4	Machine screw	43	300107	8	Lock nut
20	262520	1	Fluid path spindle	44	S44-10	4	Machine screw
21	S376-59	1	Machine screw	45	S270014	4	Guide roller post
22	S200-324	1	O-ring	47	270110-3.000	2	Guide roller pin
23	S7-51	4	Socket head cap screw	49	262436-2.468	2	Guide roller
24	S281-6	4	Hex flange nut	51	300070	4	Nyloc nut
25	S390030-1	4	Spacer				

Model Specific Parts - Air / Water Dispensing

Item No.	Description	No. Req'd	SD13000 OLP	SD13035 OLP	SD13050 OLP	SD14000 OLP	SD14035 OLP	SD14005 OLP	SD14050 OLP	SD14050 OLP-HTH
1	Drive shaft	1	262536-8	262536-8	262536-8	262536-8	262536-8	262536-10	262536-10	262536-10
5	Tie rod	4	260402-170	260402-170	260402-170	260402-170	260402-170	260402-140	260402-140	260402-140
14	Drum	1	262524-8	262524-8	262524-8	262524-8	262524-8	262524-10	262524-10	262524-10
16	Reducing bushing	1	270025	270025	270025	NONE	NONE	NONE	NONE	NONE
28	Spring & case assembly	1	S602455-1	S602455-1	S602455-1	S602455-1	S602455-1	S602455-1	S602455-1	S602455-1
34	Tie plate	1	262532-8	262532-8	262532-8	262532-8	262532-8	262532-10	262532-10	262532-10
41	Swivel assembly	1	600682	600682	600682	600682	600682	600682	600682	600682-1
46	Guide roller pin	2	270110-8.750	270110-8.750	270110-8.750	270110-8.750	270110-8.750	270110-10.750	270110-10.750	270110-10.750
48	Guide roller	2	262436-8.218	262436-8.218	262436-8.218	262436-8.218	262436-8.218	262436-10.218	262436-10.218	262436-10.218
50	Tie plate	1	262531-8	262531-8	262531-8	262531-8	262531-8	262531-10	262531-10	262531-10
N/A	Hose assembly	1	NONE	601034-35	601034-50	NONE	601027-35	NONE	S601027-50	601147-50
N/A	Bumper stop assembly	1	NONE	3-HR1005	3-HR1005	NONE	4-HR1005	NONE	4-HR1005	4-HR1005
---	Maximum pressure		500 PSI	250 PSI	250 PSI	500 PSI	250 PSI	500 PSI	250 PSI	300 PSI
---	Maximum temperature		210 °F	150 °F	150 °F	210 °F	150 °F	210 °F	150 °F	212 °F (Air) 180 °F (Water)

Model Specific Parts - Oil Dispensing

Item No.	Description	No. Req'd	SD13000 OMP	SD13035 OMP	SD13050 OMP
1	Drive shaft	1	262536-8	262536-8	262536-8
5	Tie rod	4	260402-170	260402-170	260402-170
14	Drum	1	262524-8	262524-8	262524-8
16	Reducing bushing	1	300055	300055	300055
28	Spring & case assembly	1	S602455-2	S602455-2	S602455-2
34	Tie plate	1	262532-8	262532-8	262532-8
41	Swivel assembly	1	600682	600682	600682
46	Guide roller pin	2	270110-8.750	270110-8.750	270110-8.750
48	Guide roller	2	262436-8.218	262436-8.218	262436-8.218
50	Tie plate	1	262531-8	262531-8	262531-8
N/A	Hose assembly	1	NONE	601037-35	601037-50
N/A	Bumper stop assembly	1	NONE	3-HR1005	3-HR1005
---	Maximum pressure		3000 PSI	1250 PSI	1250 PSI
---	Maximum temperature		210 °F	210 °F	210 °F

Model Specific Parts - Fuel Dispensing

Item No.	Description	No. Req'd	FSD13000 OLP	FSD13035 OLP	FSD13050 OLP	FSD14000 OLP	FSD14035 OLP	FSD14005 OLP	FSD14050 OLP
1	Drive shaft	1	262536-8	262536-8	262536-8	262536-10	262536-8	262536-8	262536-10
5	Tie rod	4	260402-170	260402-170	260402-170	260402-140	260402-170	260402-170	260402-140
14	Drum	1	262524-8	262524-8	262524-8	262524-10	262524-8	262524-8	262524-10
16	Reducing bushing	1	270025	270025	270025	None	None	None	None
28	Spring & case assembly	1	S602455-1	S602455-1	S602455-1	S602455-1	S602455-1	S602455-1	S602455-1
34	Tie plate	1	262532-8	262532-8	262532-8	262532-10	262532-8	262532-8	262532-10
41	Swivel assembly	1	600682-2	600682-2	600682-2	600682-2	600682-2	600682-2	600682-2
46	Guide roller pin	2	270110-8.750	270110-8.750	270110-8.750	270110-10.750	270110-8.750	270110-8.750	270110-10.750
48	Guide roller	2	262436-8.218	262436-8.218	262436-8.218	262436-10.218	262436-8.218	262436-8.218	262436-10.218
50	Tie plate	1	262531-8	262531-8	262531-8	262531-10	262531-8	262532-8	262531-10
N/A	Hose assembly	1	None	S600160-4	S600160-2	None	S600451-35	None	S600451-50
N/A	Bumper stop assembly	1	None	3-HR1005	3-HR1005	None	4-HR1005	None	4-HR1005
---	Maximum pressure		500 PSI	50 PSI	50 PSI	500 PSI	50 PSI	500 PSI	50 PSI
---	Maximum temperature		210 °F	150 °F	150 °F	210 °F	150 °F	210 °F	150 °F

Model Specific Parts - Vacuum Recovery

Item No.	Description	No. Req'd	SD13000 OVP	SD13035 OVP	SD13050 OVP	SD14000 OVP	SD14035 OVP	SD14005 OVP	SD14050 OVP
1	Drive shaft	1	262536-8	262536-8	262536-8	262536-8	262536-8	262536-10	262536-10
5	Tie rod	4	260402-170	260402-170	260402-170	260402-170	260402-170	260402-140	260402-140
14	Drum	1	262524-8	262524-8	262524-8	262524-8	262524-8	262524-10	262524-10
16	Reducing bushing	1	270025	270025	270025	None	None	None	None
28	Spring & case assembly	1	S602455-1	S602455-1	S602455-1	S602455-2	S602455-2	S602455-2	S602455-2
34	Tie plate	1	262532-8	262532-8	262532-8	262532-8	262532-8	262532-10	262532-10
41	Swivel assembly	1	600682	600682	600682	600682	600682	600682	600682
46	Guide roller pin	2	270110-8.750	270110-8.750	270110-8.750	270110-8.750	270110-8.750	270110-10.750	270110-10.750
48	Guide roller	2	262436-8.218	262436-8.218	262436-8.218	262436-8.218	262436-8.218	262436-10.218	262436-10.218
50	Tie plate	1	262531-8	262531-8	262531-8	262531-8	262531-8	262531-10	262531-10
N/A	Hose assembly	1	None	601102-35	601102-50	None	601103-35	None	601103-50
N/A	Bumper stop assembly	1	None	3-HR1005	3-HR1005	None	4-HR1005	None	4-HR1005
---	Maximum pressure		28 Hg~300 PSI	28 Hg~300 PSI	28 Hg~300 PSI	28 Hg~300 PSI	28 Hg~300 PSI	28 Hg~300 PSI	28 Hg~300 PSI
---	Maximum temperature		210 °F	210 °F	210 °F	210 °F	210 °F	210 °F	210 °F